

FIG. 1

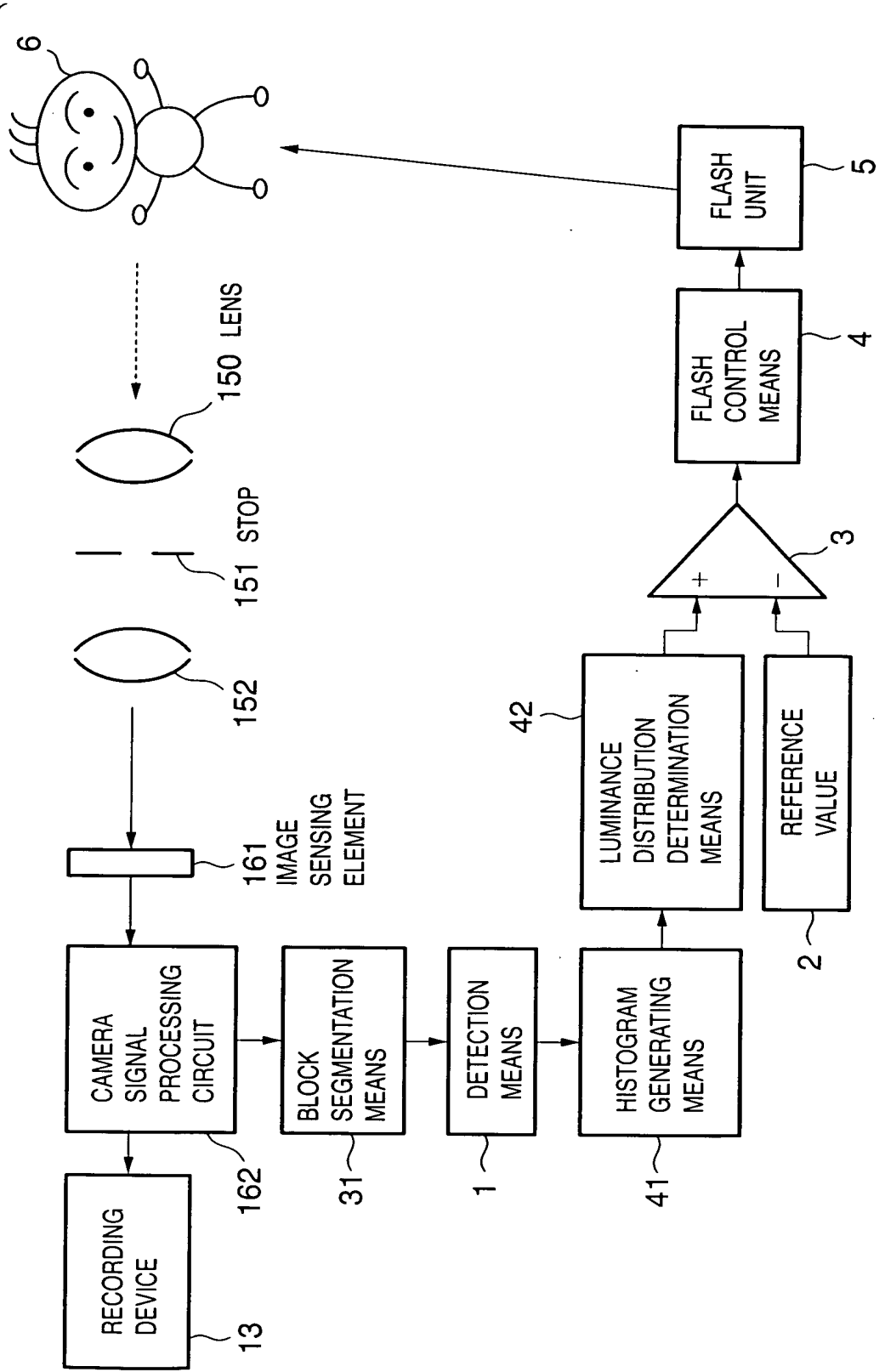
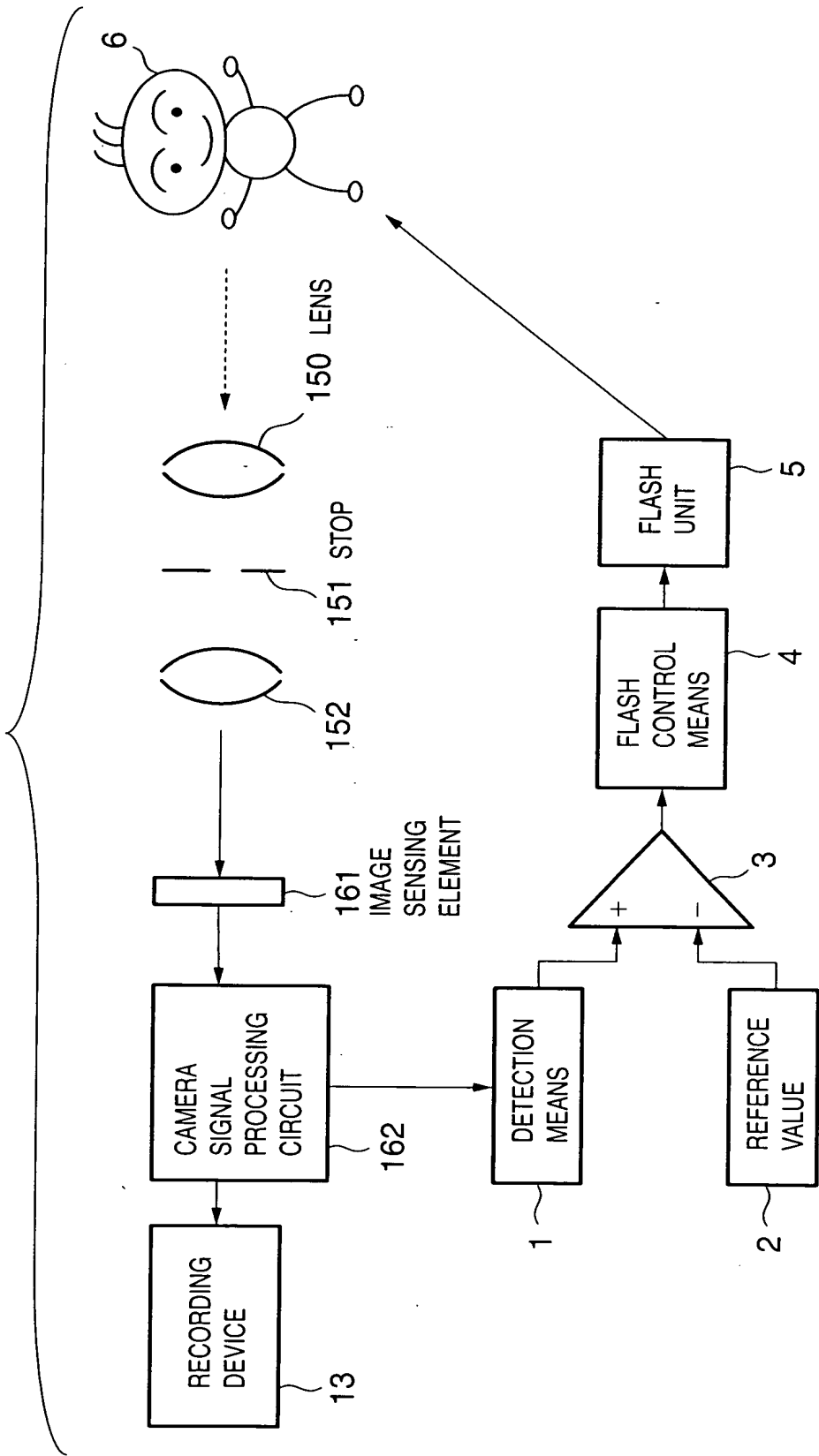
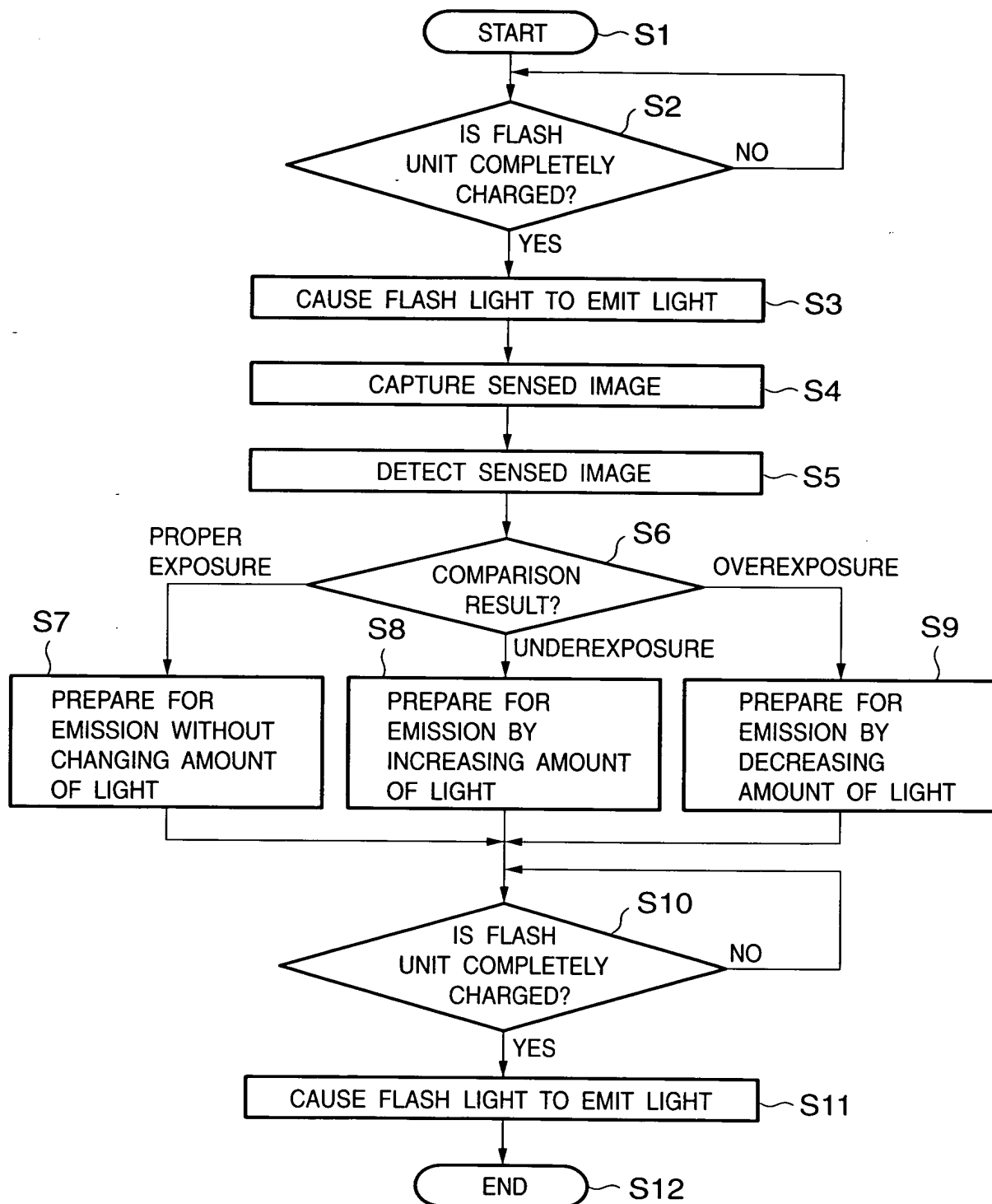


FIG. 2

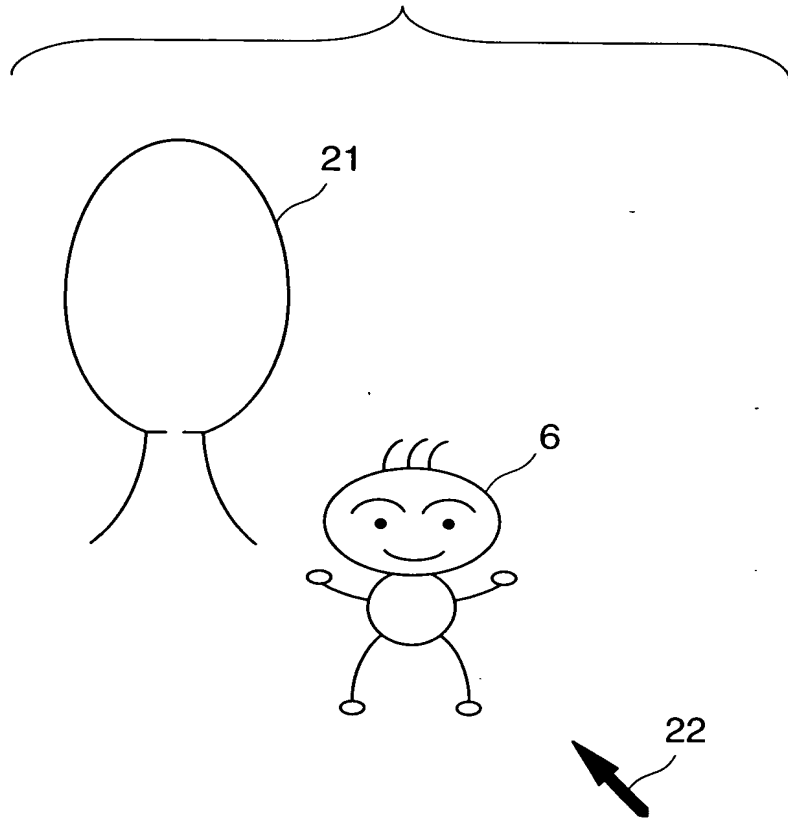


# FIG. 3



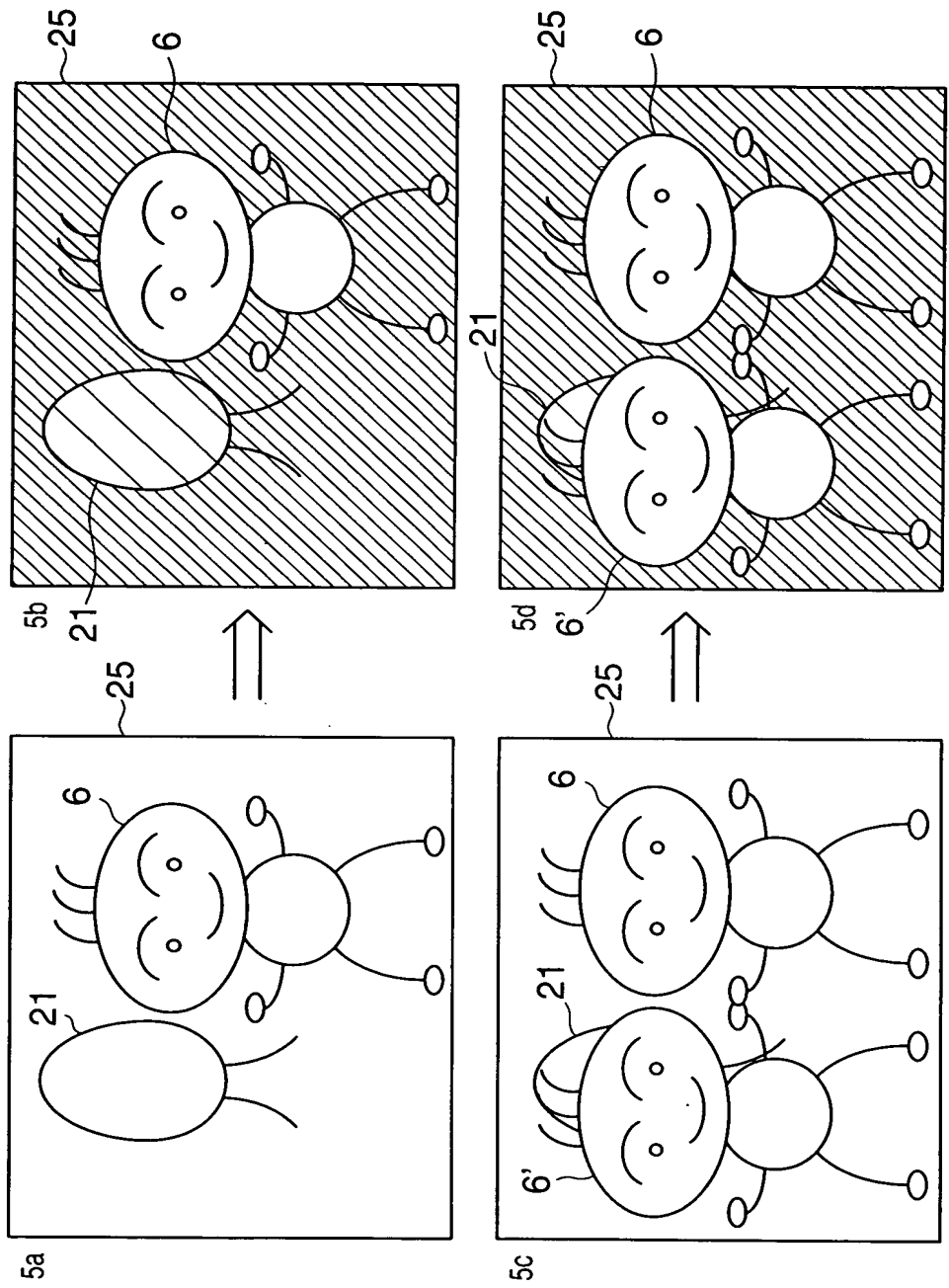
TOP SECRET

**FIG. 4**



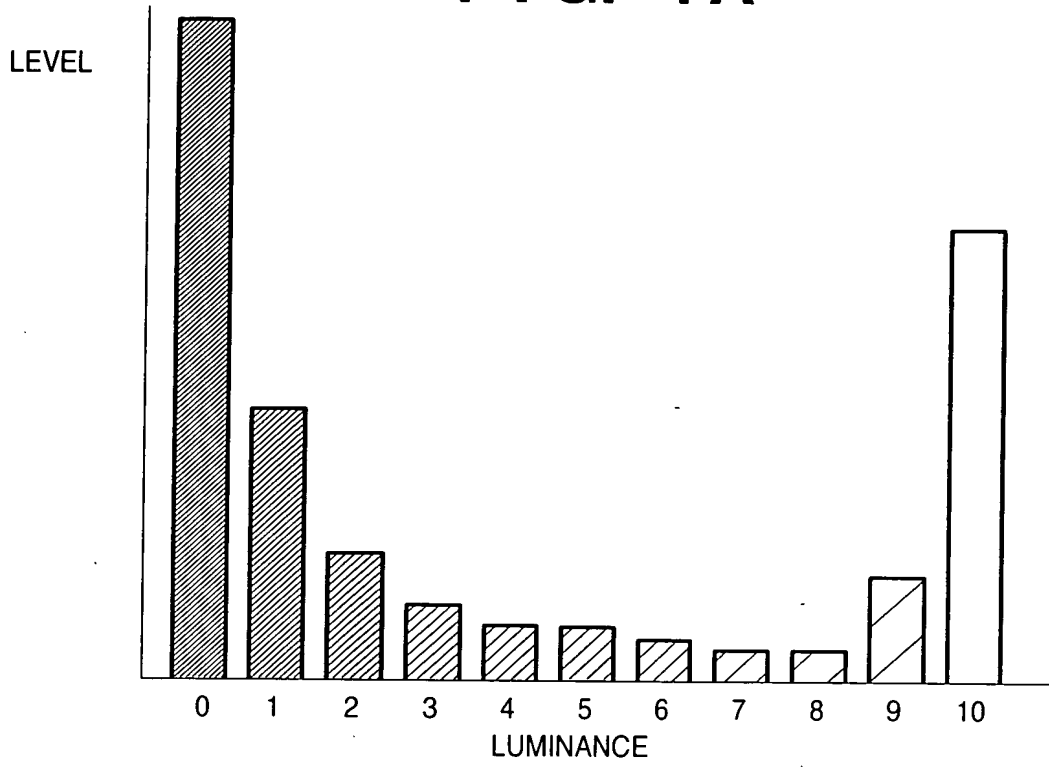
Patent # 5,110,260

FIG. 5

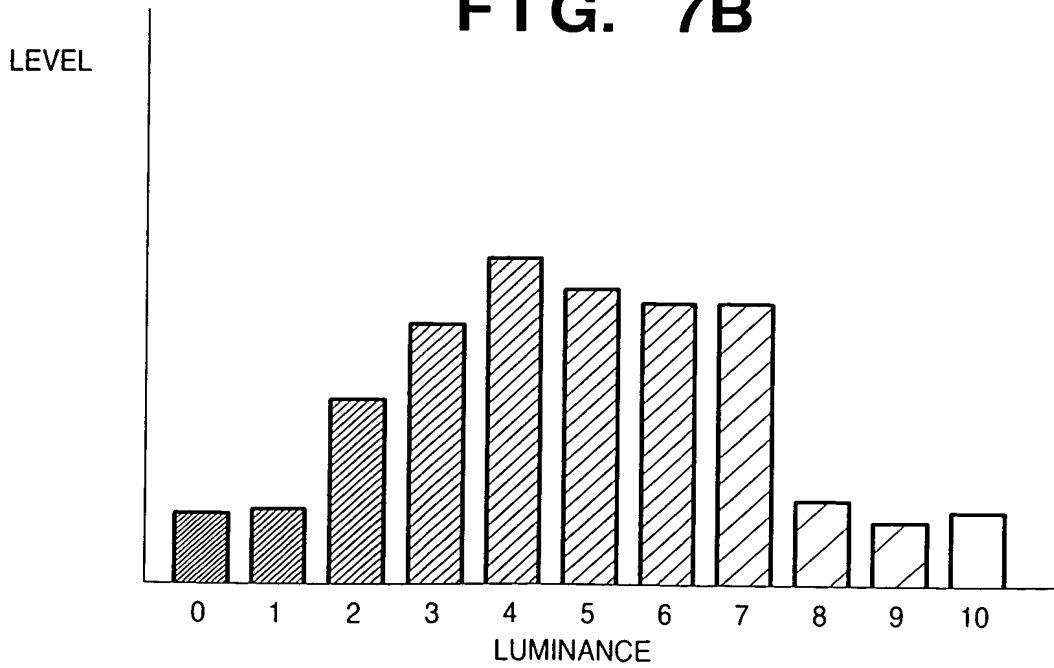




**FIG. 7A**

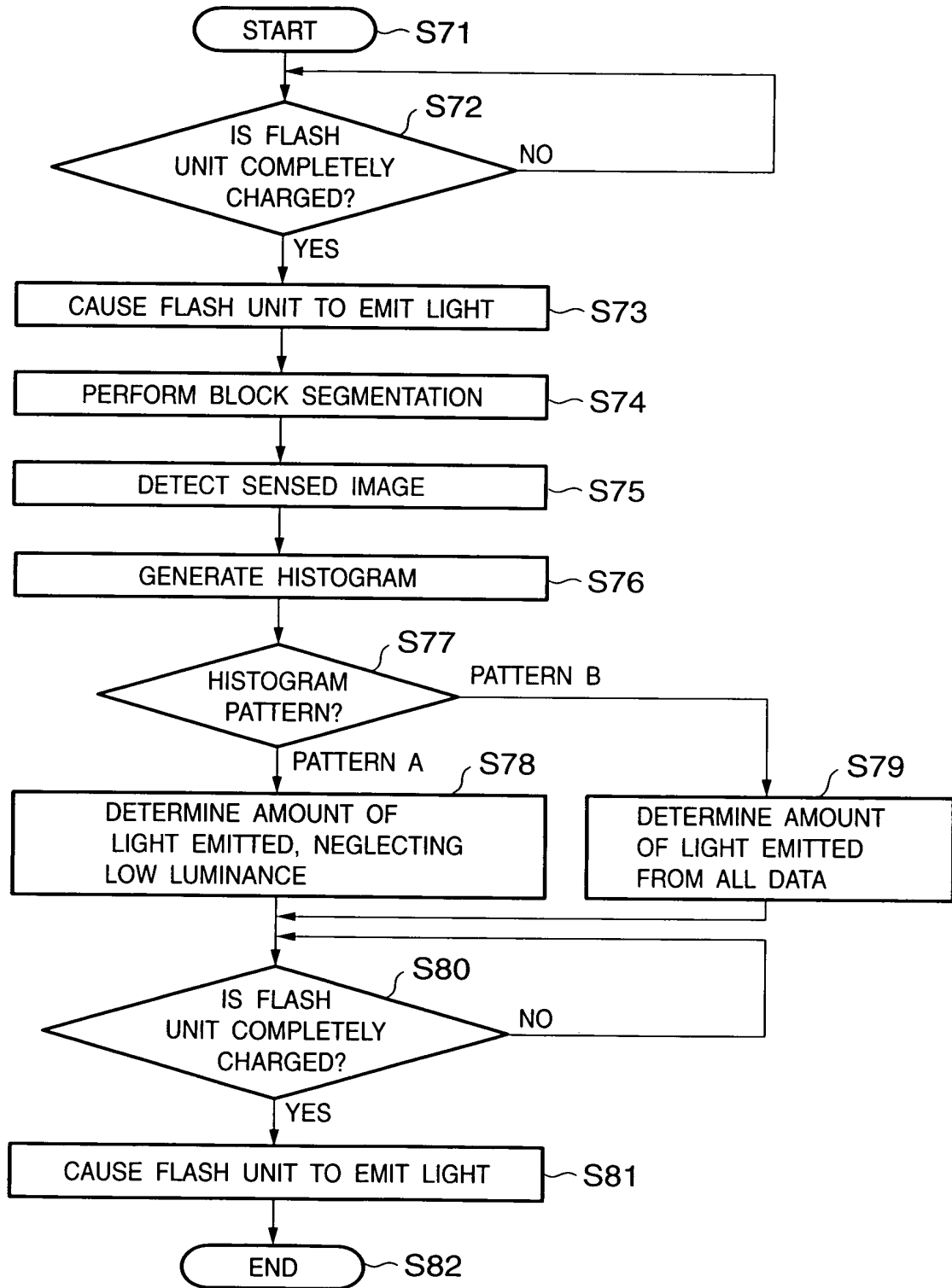


**FIG. 7B**



10520 9164460

FIG. 8



FOR PAGES 8 AND 9



FIG. 9

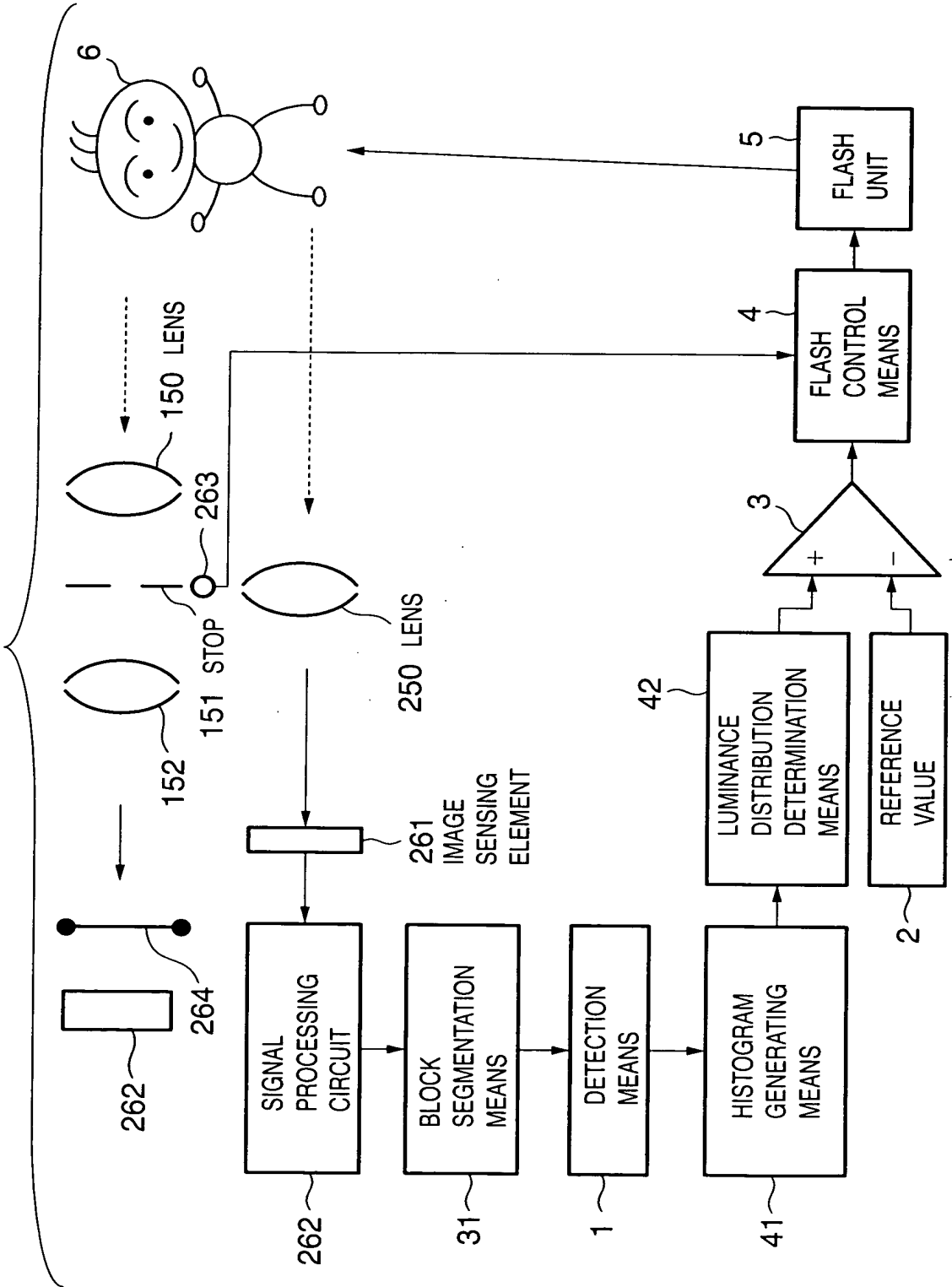
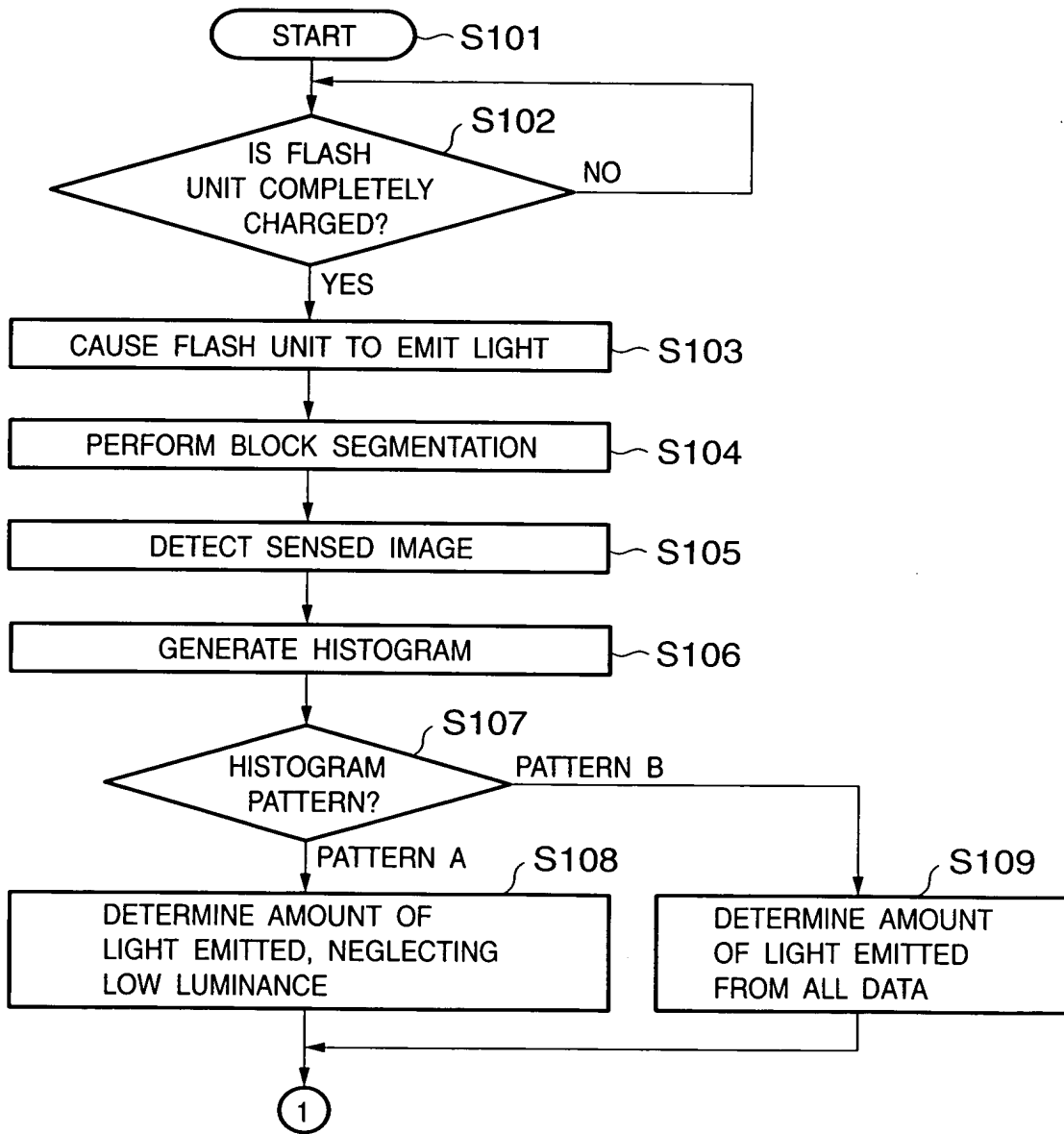
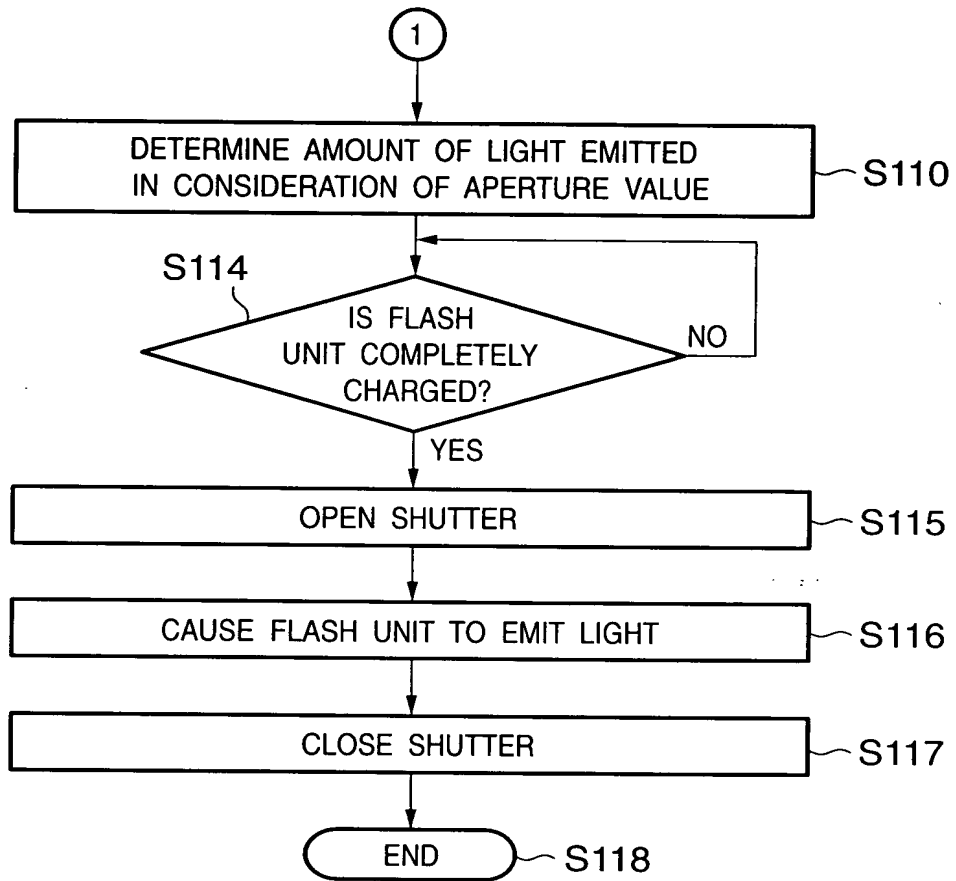


FIG. 10A



10300 316260

# FIG. 10B



P03000 5162260

FIG. 11

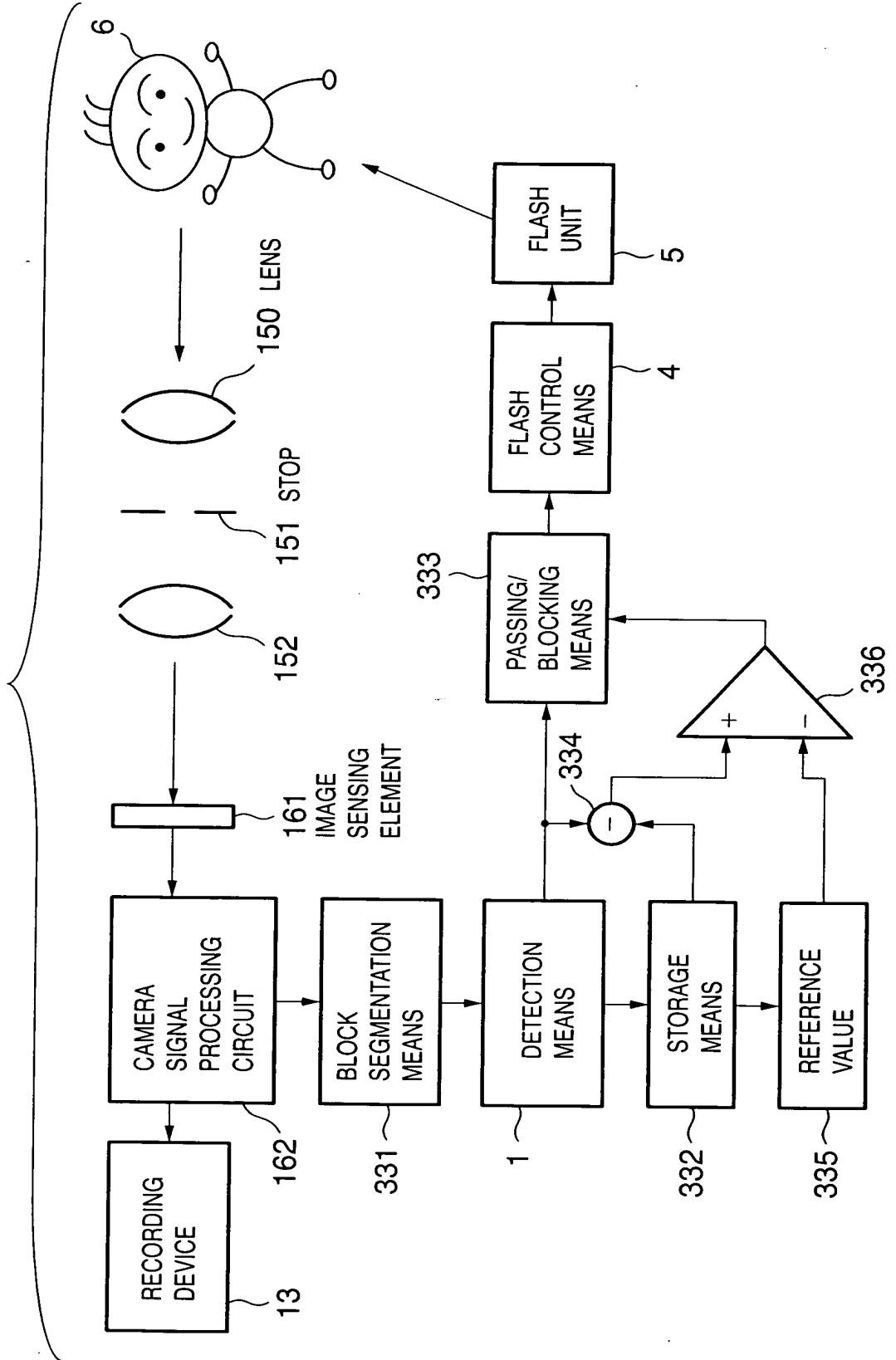


FIG. 12A

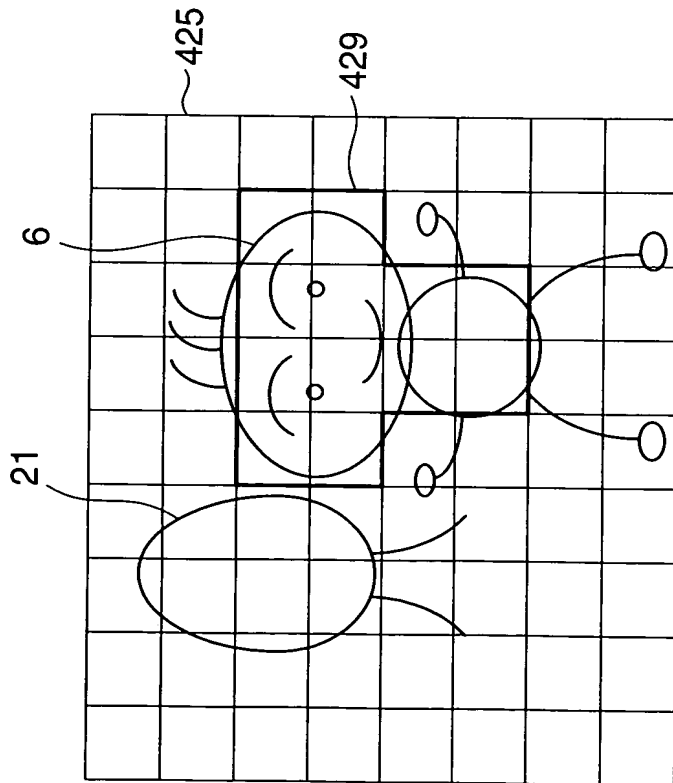
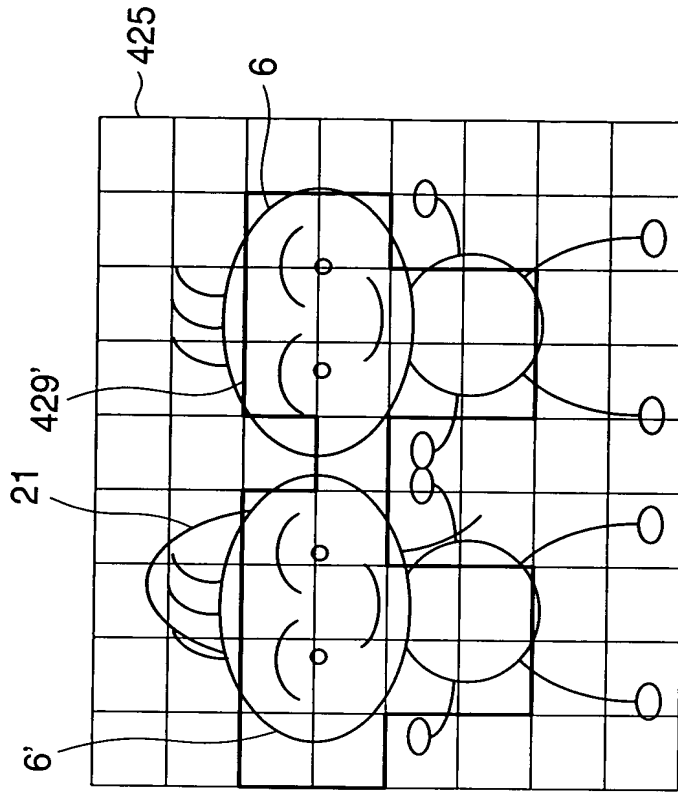
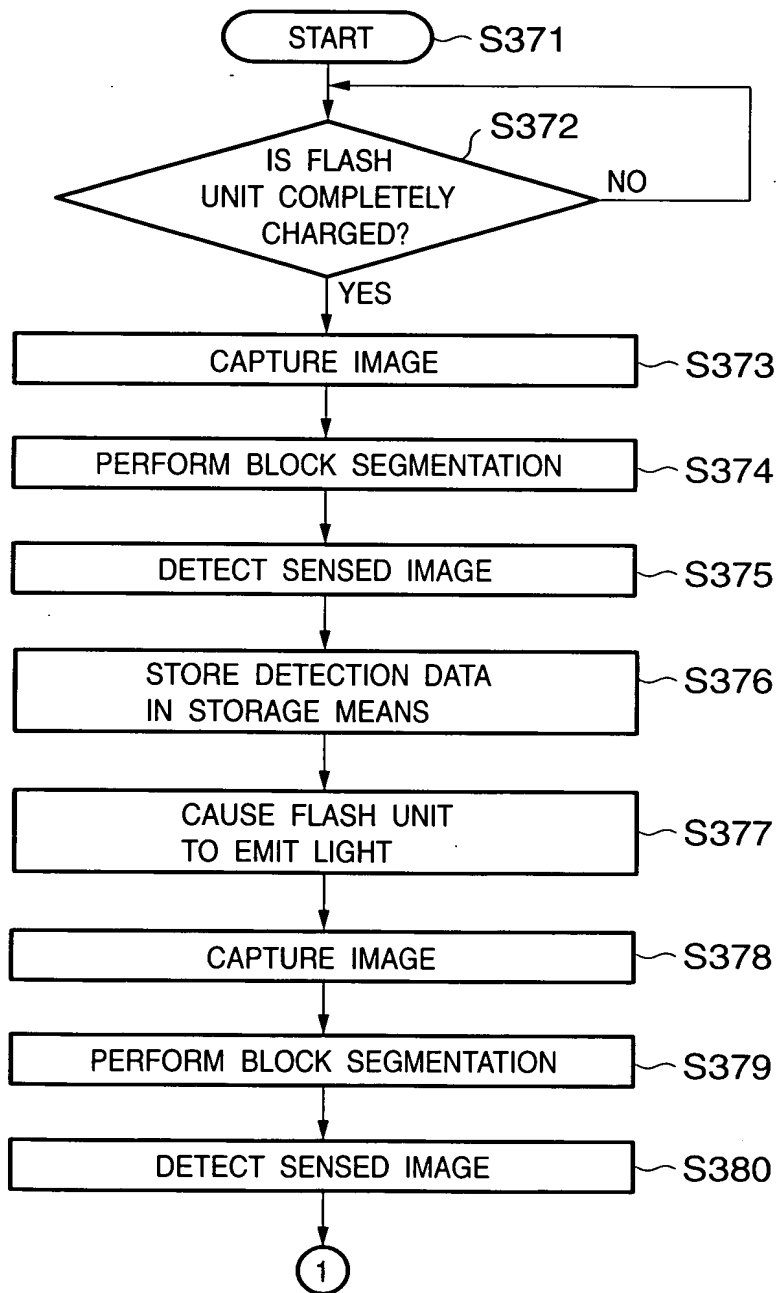


FIG. 12B

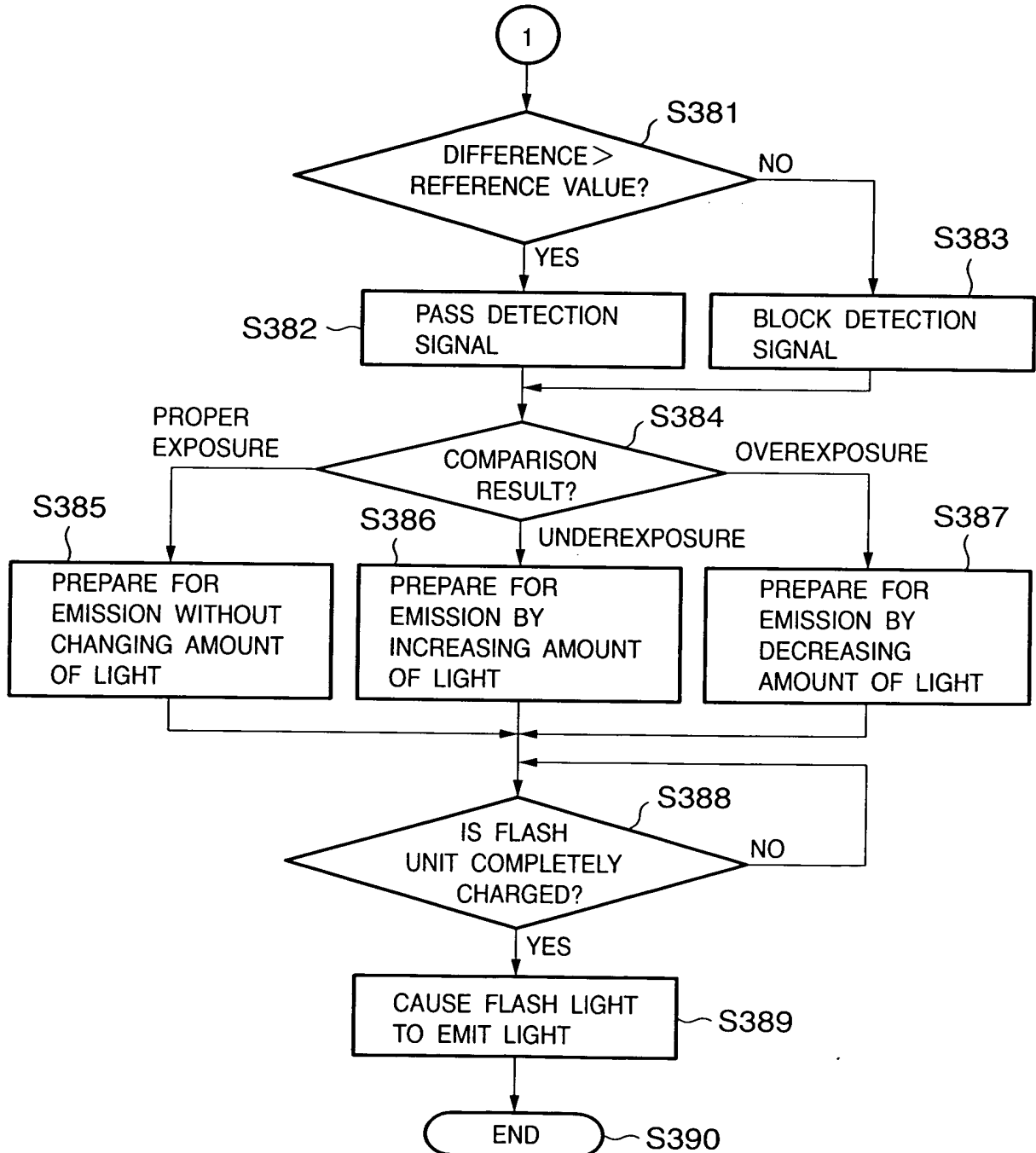


# FIG. 13A



9972622

# FIG. 13B



2025 RELEASE UNDER E.O. 14176

FIG. 14

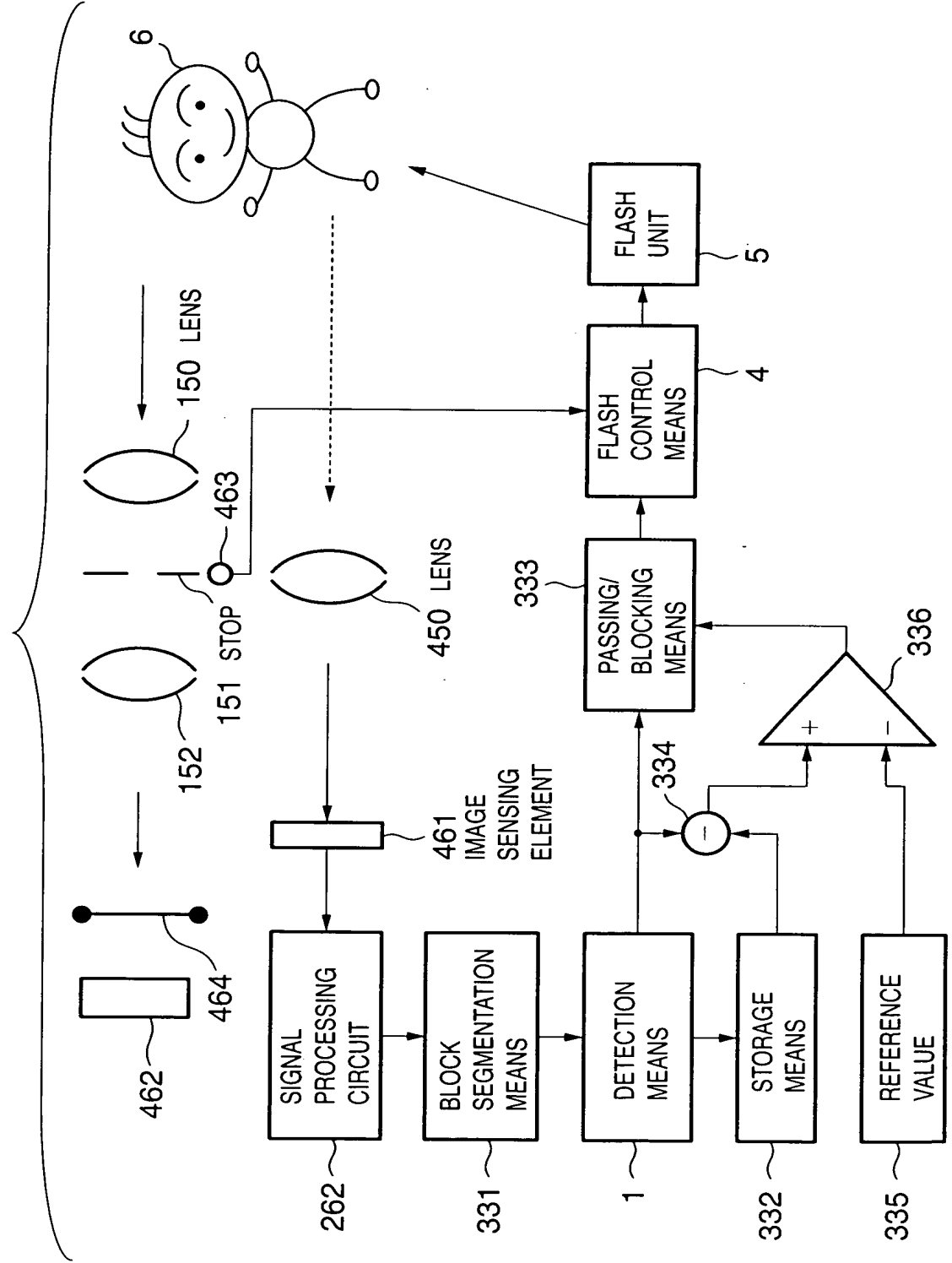
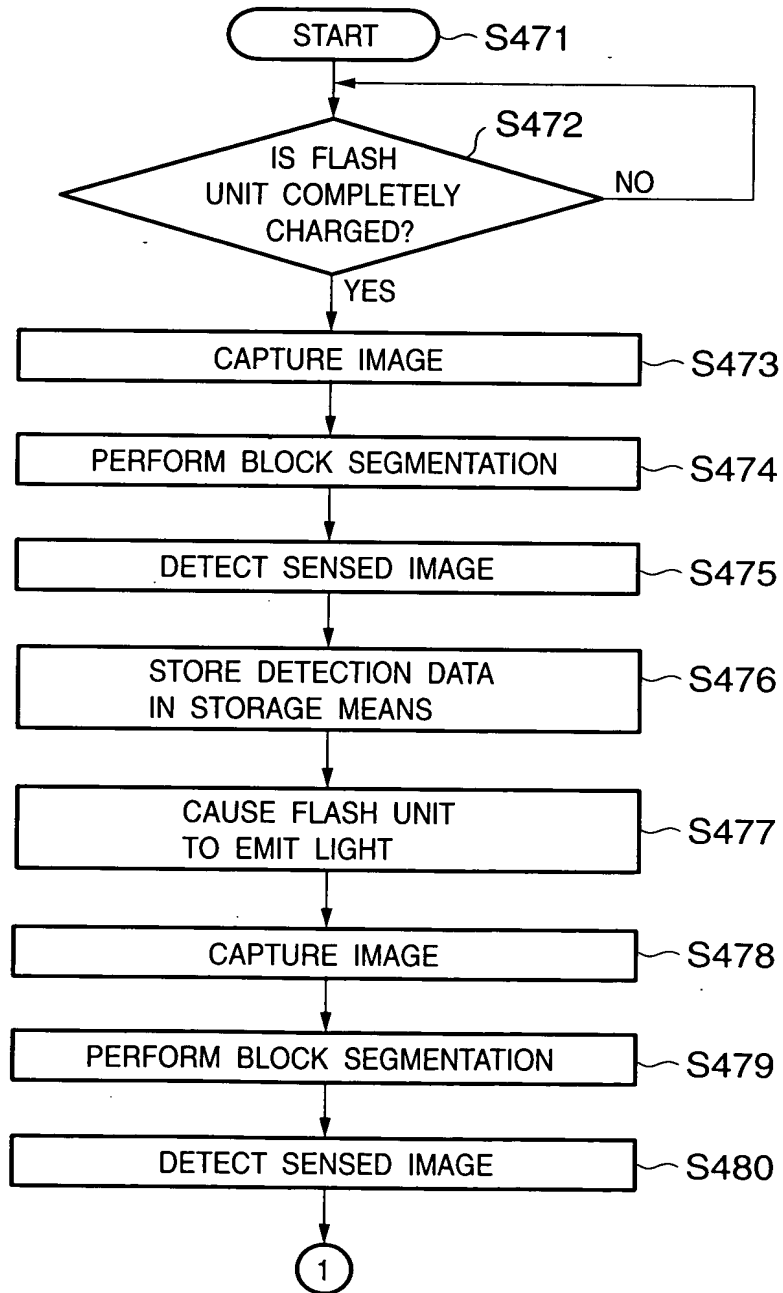


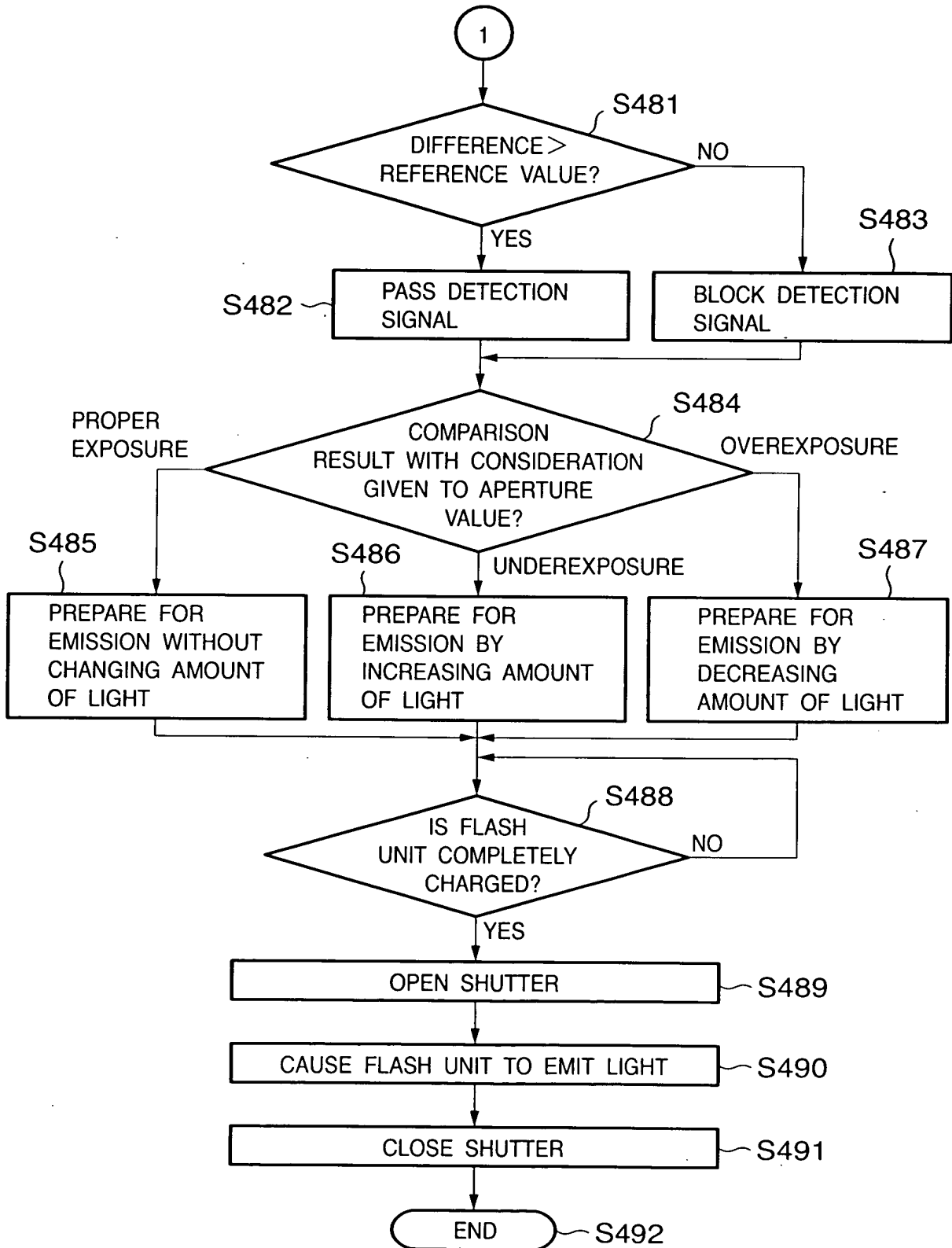


FIG. 15A



TOP SECRET

FIG. 15B



FILED 9-10-60